









The externally powered zone anchor with back up battery for localization of assets equipped with Bluetooth tag trackers in a dedicated zone. The zone anchors scans continuously when net powered.

-  Installed at a fixed location
-  Scans Bluetooth Low Energy tag trackers
-  NB-IoT
-  Europe and North America
-  IP 67
-  Flame retardant
-  IK09
-  Net powered
-  Back up battery

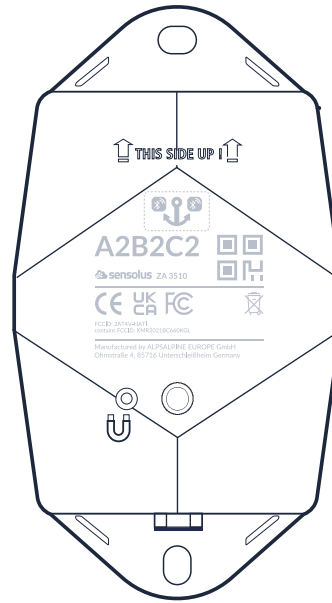

Connectivity

NB-IoT

- Energy efficient transceiver
- Internal omnidirectional antenna
- Bi-directional communication
- NB-IoT bands: Europe and North America
- Data recovery
- OTA firmware upgrade (NB-IoT)

Bluetooth Low Energy (BLE)

- Bluetooth Low Energy 5.0
- Over the air firmware upgrade (BLE)

Mounting

- [Activation manual](#)
- Holes 7x9mm ($\frac{9}{32}$ * $\frac{23}{64}$ in) for screws or rivets. 115 mm ($4\frac{17}{32}$ in) distance between the centers of the mounting holes.
- Instructions for mounting the device are available in the [Sensolus documentation center](#).

Mechanics & design

Antennas

All antennas are internal

Size

130x72x36 mm ($5\frac{1}{8} \times 2\frac{53}{64} \times 1\frac{27}{64}$ in)(L W H)

Weight

218,3 gram (7.68 oz) without cable

Color

White and black

Casing

- PBT/PC 29 TM-Z2 FR UV LS
- Flame retardant
- UV-stabilized

Power supply

- 220-230 V Europe
- 110-115 V North America
- power supply cable length 2 meter

Back up battery

Back up battery lifetime when scanning

Utilize the Sensolus battery calculator to assess the lifespan of the backup battery, which varies based on the specific use case.

Water & dust resistance

IP 67

Impact resistance

IK 09

Drop shock and vibration

EN 60068

Operating temperature

-20°C to 60°C (-4°F to 140°F) *

The specifics regarding operational temperature are contingent upon the application, installation circumstances, and environmental factors such as sunlight exposure. For further information, please reach out to Sensolus. Battery life can be affected when devices function for extended periods at the extremes of this range.

Certifications

Regulatory

- CE
- FCC
- IC

Electrical safety

EN 62368-1

User interaction

Device activation

Magnetic activation

Synchronize remote settings

- Instant: Magnet activation
- Periodic: No user interaction needed

Back up battery characteristics

- User replaceable battery pack (Li-SoCl₂) 12000 mAh
- 2.94 gram (0.1037oz) lithium

Bluetooth 5.0

D068598

Environmental

Drop shock

LED feedback

Green & red LED feedback on the device

Management services

Diagnostics

- Battery lifetime prediction
- Detailed energy consumption
- Installation
- Communication quality

Management

- OTA firmware updates over NB-IoT and BLE
- Remote configuration
- Zone anchor localization with Sensolus smartphone app

Application services

- Bluetooth tag tracker scanning
- Act as managed geobeacon

Tag tracker scanning

- Compatible with all Sensolus supported Bluetooth tag trackers
- Continuously scans up to 2000 Bluetooth tag trackers when net powered*

* Discuss with Sensolus when more than 2000 Bluetooth tag trackers need to be scanned at once

Firmware configuration

Bluetooth tag tracker scanning configurations

- Scan and send interval
- Bluetooth tag tracker's RSSI scan threshold
- Filter scanned Bluetooth tag trackers on UUID

Use as geobeacon

Enabled or disabled

Security

- Device unique encryption keys
- End to end payload encryption Chacha 20

- AES encrypted firmware
- Firmware upgrade allows only signed firmware images

Measurements

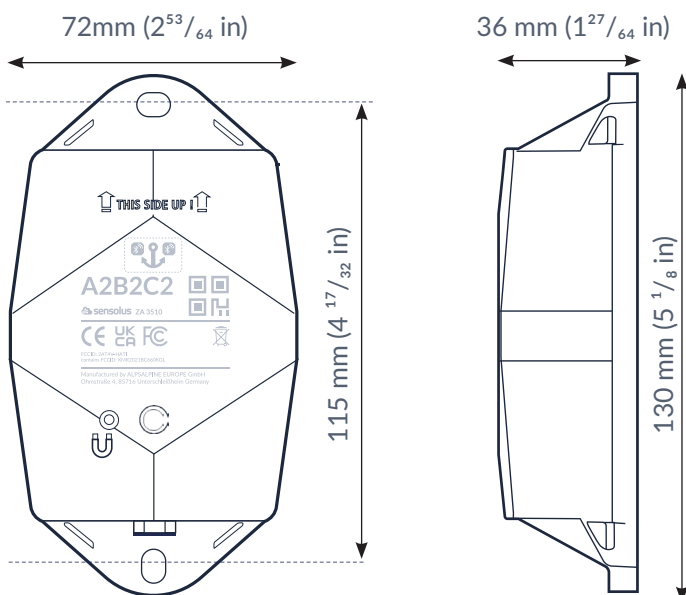

Accessories

The ZA 3510 does not ship with a power adaptor. Sensolus has power adaptors for EU, UK and USA.

- ADPT 8500 EU - ZA 3510 net power adaptor EU version
- ADPT 8501 UK - ZA 3510 net power adaptor UK version
- ADPT 8502 US - ZA 3510 net power adaptor US version