







The long-life battery powered WIFI tracker with tamper alert.

-  Wi-Fi
-  Network triangulation
-  Sigfox
-  Up to 7 years of battery life
-  IP67
-  Tamper detection

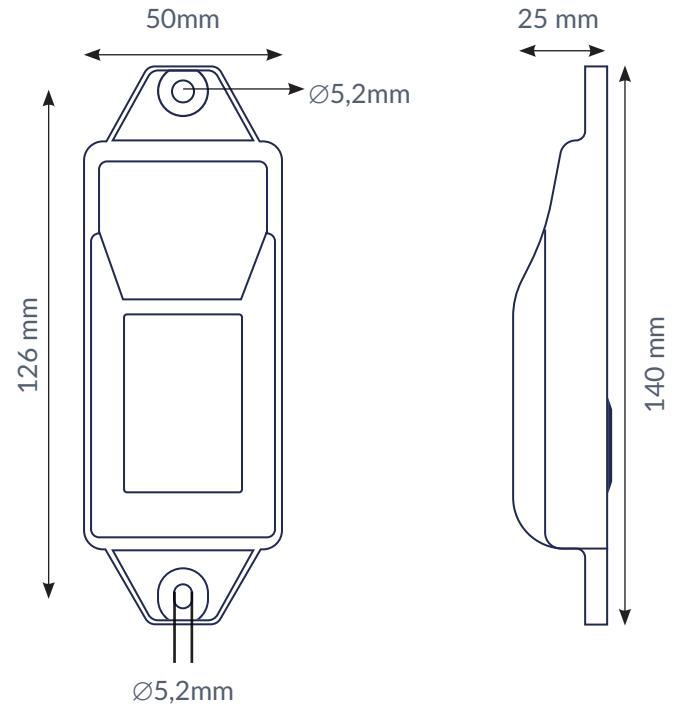

Connectivity

Sigfox

- Energy efficient transceiver
- Bi-directional communication
- Regions: RC1

Geolocalization

Wi-Fi

Wi-Fi based geolocalization

Sigfox Atlas

Network based geolocalization

Sensing

Internal

- Physical tamper detection
- Relocation based on acceleration

Mounting

Holes Ø5,2mm for rivets

Mechanics & design

Antennas

All antennas are internal

Size

140 x50x25 mm (L W H)

Weight

95 gram

Color

Black

Water & dust resistance

IP67

Operating temperature

-20°C to 60°C

Casing

Polycarbonat

Battery

- 7 years at 2 messages per day
- Non replaceable battery 3400 mAh 3.6 V (Li-SoCl₂)
- <1 gram Lithium

Certifications

Sigfox

RC1

Regulatory

CE

User interaction

Device activation

Activation with the tamper button

LED feedback

No LED feedback on the device

Synchronize remote settings

Periodic: No user interaction needed

Management services

Diagnostics

- 4 battery levels
- Communication quality

Management

- Remote configuration
- Tracker usage profiles

Application services

Localization

Geozones

Firmware configuration

Communication service

Data recovery configuration (optional)

General configuration

- Boot methods
- Time synchronization

Location service

Periodic and relocation parameters

Tamper service

Physical tamper button at the back of the device

Security

Sigfox communication AES encryption